

Hisense

Dehumidifier Use & Care Guide

Thank you very much for purchasing this dehumidifier. Please read this use and care guide carefully before using this appliance and keep this manual for future reference.

ENGLISH

ITALIANO

ESPAÑOL

FRANÇAIS

РУССКИЙ ЯЗЫК

DEUTSCH

SERBIAN

TABLE OF CONTENTS

PRODUCT OVERVIEW	1
SAFETY PRECAUTIONS	2
DEHUMIDIFIER SAFETY	9
INSTALLATION REQUIREMENTS	12
Electrical Requirements	12
Location Requirements	12
DEHUMIDIFIER USE	13
Setting the Controls	13
Draining the Dehumidifier	15
Normal Sounds	16
DEHUMIDIFIER CARE	17
Cleaning the Air Filter	17
Cleaning the Dehumidifier	17
TROUBLE SHOOTING	18

SAFETY INSTRUCTIONS

This appliance can be used by children aged from 8 years and above and persons with reduced physical, sensory or mental capabilities or lack of experience and knowledge if they have been given supervision or instruction concerning use of the appliance in a safe way and understand the hazards involved. Children shall not play with the appliance. Cleaning and user maintenance shall not be made by children without supervision.

Children should be supervised to ensure that they do not play with the appliance. If the supply cord is damaged, it must be replaced by the manufacturer, its service agent or similarly qualified persons in order to avoid a hazard. The appliance shall be installed in accordance with national wiring regulations. The range of external static pressures is -0.2Pa to 0.2Pa. Keep the unit 5m or more apart from combustible surfaces.

Do not operate your air conditioner in a wet room such as a bathroom or laundry room.

SAFEGUARDING THE ENVIRONMENT

This appliance is made of recyclable or re-usable material. Scrapping must be carried out in compliance with local waste disposal regulations. Before scrapping it, make sure to cut off the mains cord so that the appliance cannot be re-used.

For more detailed information on handling and recycling this product, contact your local authorities who deal with the separate collection of rubbish or the shop where you bought the appliance.

SCRAPPING OF APPLIANCE

This appliance is marked according to the European Directive 2012/19/EU, Waste Electrical and Electronic Equipment (WEEE).

This marking indicates that this product should not be disposed with other household wastes throughout the EU. To prevent possible harm to the environment or human health from uncontrolled waste disposal, recycle it responsibly to promote the sustainable reuse of material resources. To return your used device, please use the return and collection systems or contact the retailer where the product was purchased.





They can take this product for environmental safe recycling.



CAUTION

- Do not use means to accelerate the defrosting process or to clean, other than those recommended by the manufacturer.
- The appliance shall be stored in a room without continuously operating ignition sources (for example: open flames, an operating gas appliance or an operating electric heater).
- Do not pierce or burn.
- Be aware that refrigerants may not contain an odour.
- The appliance shall be installed, operated and stored in a room with a floor area larger than 5 m².
- Spaces where refrigerant pipes shall be compliance with national gas regulations.
- Servicing shall be performed only as recommended by the manufacturer.
- The appliance shall be stored in a well-ventilated area where the room size corresponds to the room area as specified for operation.
- All working procedure that affects safety means shall only be carried by competent persons.
- The appliance shall be stored in a room without continuously operating open flames (for example an operating gas appliance) and ignition sources (for example an operating electric heater).
- The appliance shall be so as to prevent mechanical damage from occurring.
- Any person who is involved with working on or breaking into a refrigerant circuit should hold a current valid certificate from an industry-accredited assessment authority, which authorises their competence to handle refrigerants safely in accordance with an industry recognised assessment specification.
- Servicing shall only be performed as recommended by the equipment manufacturer. Maintenance and repair requiring the assistance of other skilled personnel shall be carried out under the supervision of the person competent in the use of flammable refrigerant.

Explanation of symbols displayed on the appliance:

 Caution, risk of fire	WARNING	This symbol shows that this appliance uses a flammable refrigerant. If the refrigerant is leaked and exposed to an external ignition source, there is a risk of fire
	CAUTION	This symbol shows that the operation manual should be read carefully.
	CAUTION	This symbol shows that a service personnel should be handling this equipment with reference to the installation manual.
	CAUTION	This symbol shows that information is available such as the operating manual or installation manual.

Fuse parameter of the machine: (T2.5A, 250V).

PRODUCT OVERVIEW

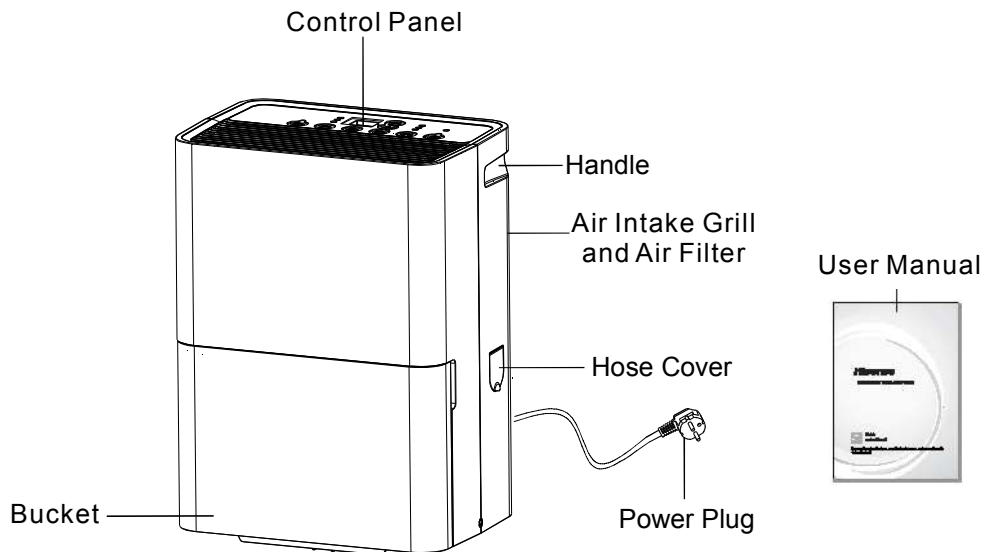

NOTE:

The figures in this manual are based on the external view of a standard model. They may differ from that dehumidifier you have selected.

SAFETY PRECAUTIONS

Precautions for using R290 refrigerant

The basic installation work procedures are the same as the conventional refrigerant (R22 or R410A). However, pay attention to the following points:

CAUTION

1. **Transport of equipment containing flammable refrigerants**

Compliance with the transport regulations

2. **Marking of equipment using signs**

Compliance with local regulations

3. **Disposal of equipment using flammable refrigerants**

Compliance with national regulations

4. **Storage of equipment/appliances**

The storage of equipment should be in accordance with the manufacturer's instructions.

5. **Storage of packed (unsold) equipment**

- Storage package protection should be constructed such that mechanical damage to the equipment inside the package will not cause a leak of the refrigerant charge.
- The maximum number of pieces of equipment permitted to be stored together will be determined by local regulations.

6. **Information on servicing**

6-1 **Checks to the area**

Prior to beginning work on systems containing flammable refrigerants, safety checks are necessary to ensure that the risk of ignition is minimised. For repair to the refrigerating system, the following precautions shall be complied with prior to conducting work on the system.

6-2 **Work procedure**

Work shall be undertaken under a controlled procedure so as to minimise the risk of flammable gas or vapour being present while the work is being performed.

6-3 **General work area**

- All maintenance staff and others working in the local area shall be instructed on the nature of work being carried out. Work in confined spaces shall be avoided.
- The area around the workspace shall be sectioned off. Ensure that the conditions within the area have been made safe by control of flammable material.

6-4 **Checking for presence of refrigerant**

- The area shall be checked with an appropriate refrigerant detector prior to and during work, to ensure the technician is aware of potentially flammable atmospheres.
- Ensure that the leak detection equipment being used is suitable for use with flammable refrigerants, i.e. non-sparking, adequately sealed or intrinsically safe.

 **CAUTION**

6-5 Presence of fire extinguisher

- If any hot work is to be conducted on the refrigeration equipment or any associated parts, appropriate fire extinguishing equipment shall be available to hand.
- Have a dry powder or CO2 fire extinguisher adjacent to the charging area.

6-6 No ignition sources

- No person carrying out work in relation to a refrigeration system which involves exposing any pipe work that contains or has contained flammable refrigerant shall use any sources of ignition in such a manner that it may lead to the risk of fire or explosion.
- All possible ignition sources, including cigarette smoking, should be kept sufficiently far away from the site of installation, repairing, removing and disposal, during which flammable refrigerant can possibly be released to the surrounding space.
- Prior to work taking place, the area around the equipment is to be surveyed to make sure that there are no flammable hazards or ignition risks. “No Smoking” signs shall be displayed.

6-7 Ventilated area

- Ensure that the area is in the open or that it is adequately ventilated before breaking into the system or conducting any hot work.
- A degree of ventilation shall continue during the period that the work is carried out.
- The ventilation should safely disperse any released refrigerant and preferably expel it externally into the atmosphere.

6-8 Checks to the refrigeration equipment

- Where electrical components are being changed, they shall be fit for the purpose and to the correct specification.
- At all times the manufacturer's maintenance and service guidelines shall be followed. If in doubt consult the manufacturer's technical department for assistance.
- The following checks shall be applied to installations using flammable refrigerants:
 - The charge size is in accordance with the room size within which the refrigerant containing parts are installed;
 - The ventilation machinery and outlets are operating adequately and are not obstructed;
 - If an indirect refrigerating circuit is being used, the secondary circuit shall be checked for the presence of refrigerant;
 - Marking to the equipment continues to be visible and legible. Markings and signs that are illegible shall be corrected;
 - Refrigeration pipe or components are installed in a position where they are unlikely to be exposed to any substance which may corrode refrigerant containing components, unless the components are constructed of materials

 **CAUTION**

which are inherently resistant to being corroded or are suitably protected against being so corroded.

6-9 Checks to electrical devices

- Repair and maintenance to electrical components shall include initial safety checks and component inspection procedures.
- If a fault exists that could compromise safety, then no electrical supply shall be connected to the circuit until it is satisfactorily dealt with.
- If the fault cannot be corrected immediately but it is necessary to continue operation, an adequate temporary solution shall be used.
- This shall be reported to the owner of the equipment so all parties are advised.
- Initial safety checks shall include:
 - That capacitors are discharged: this shall be done in a safe manner to avoid possibility of sparking;
 - That there no live electrical components and wiring are exposed while charging, recovering or purging the system;
 - That there is continuity of earth bonding.

7. Repairs to sealed components

- During repairs to sealed components, all electrical supplies shall be disconnected from the equipment being worked upon prior to any removal of sealed covers, etc.
- If it is absolutely necessary to have an electrical supply to equipment during servicing, then a permanently operating form of leak detection shall be located at the most critical point to warn of a potentially hazardous situation.
- Particular attention shall be paid to the following to ensure that by working on electrical components, the casing is not altered in such a way that the level of protection is affected.
- This shall include damage to cables, excessive number of connections, terminals not made to original specification, damage to seals, incorrect fitting of glands, etc.
- Ensure that apparatus is mounted securely.
- Ensure that seals or sealing materials have not degraded such that they no longer serve the purpose of preventing the ingress of flammable atmospheres.
- Replacement parts shall be in accordance with the manufacturer's specifications.

NOTE:

The use of silicon sealant may inhibit the effectiveness of some types of leak detection equipment. Intrinsically safe components do not have to be isolated prior to working on them.

8. Repair to intrinsically safe components

- Do not apply any permanent inductive or capacitance loads to the circuit without ensuring that this will not exceed the permissible voltage and current permitted for the equipment in use.
- Intrinsically safe components are the only types that can be worked on while

 **CAUTION**

live in the presence of a flammable atmosphere. The test apparatus shall be at the correct rating.

- Replace components only with parts specified by the manufacturer.
- Other parts may result in the ignition of refrigerant in the atmosphere from a leak.

9. Cabling

- Check that cabling will not be subject to wear, corrosion, excessive pressure, vibration, sharp edges or any other adverse environmental effects.
- The check shall also take into account the effects of aging or continual vibration from sources such as compressors or fans.

10. Detection of flammable refrigerants

- Under no circumstances shall potential sources of ignition be used in the searching for or detection of refrigerant leaks.
- A halide torch (or any other detector using a naked flame) shall not be used.

11. Leak detection methods

- The following leak detection methods are deemed acceptable for systems containing flammable refrigerants:
 - Electronic leak detectors shall be used to detect flammable refrigerants, but the sensitivity may not be adequate, or may need re-calibration. (Detection equipment shall be calibrated in a refrigerant-free area.)
 - Ensure that the detector is not a potential source of ignition and is suitable for the refrigerant used.
 - Leak detection equipment shall be set at a percentage of the LFL of the refrigerant and shall be calibrated to the refrigerant employed and the appropriate percentage of gas (25 % maximum) is confirmed.
 - Leak detection fluids are suitable for use with most refrigerants but the use of detergents containing chlorine shall be avoided as the chlorine may react with the refrigerant and corrode the copper pipe-work.
 - If a leak is suspected, all naked flames shall be removed/ extinguished.
 - If a leakage of refrigerant is found which requires brazing, all of the refrigerant shall be recovered from the system, or isolated (by means of shut off valves) in a part of the system remote from the leak.
 - Oxygen free nitrogen (OFN) shall then be purged through the system both before and during the brazing process.

12. Removal and evacuation

- When breaking into the refrigerant circuit to make repairs – or for any other purpose – conventional procedures shall be used.
- However, it is important that best practice is followed since flammability is a consideration.
- The following procedure shall be adhered to:
 - Remove refrigerant;
 - Purge the circuit with inert gas;

 **CAUTION**

- Evacuate;
- Purge again with inert gas;
- Open the circuit by cutting or brazing.
- The refrigerant charge shall be recovered into the correct recovery cylinders.
- The system shall be “flushed” with OFN to render the unit safe.
- This process may need to be repeated several times.
- Compressed air or oxygen shall not be used for this task.
- Flushing shall be achieved by breaking the vacuum in the system with OFN and continuing to fill until the working pressure is achieved, then venting to atmosphere, and finally pulling down to a vacuum.
- This process shall be repeated until no refrigerant is within the system. When the final OFN charge is used, the system shall be vented down to atmospheric pressure to enable work to take place.
- This operation is absolutely vital if brazing operations on the pipe-work are to take place.
- Ensure that the outlet for the vacuum pump is not close to any ignition sources and there is ventilation available.

13. Charging procedures

- In addition to conventional charging procedures, the following requirements shall be followed:
 - Ensure that contamination of different refrigerants does not occur when using charging equipment.
 - Hoses or lines shall be as short as possible to minimise the amount of refrigerant contained in them.
 - Cylinders shall be kept upright.
 - Ensure that the refrigeration system is earthed prior to charging the system with refrigerant.
 - Label the system when charging is complete (if not already).
 - Extreme care shall be taken not to overfill the refrigeration system.
- Prior to recharging the system it shall be pressure tested with OFN.
- The system shall be leak tested on completion of charging but prior to commissioning.
- A follow up leak test shall be carried out prior to leaving the site.

14. Decommissioning

- Before carrying out this procedure, it is essential that the technician is completely familiar with the equipment and all its detail.
- It is recommended good practice that all refrigerants are recovered safely.
- Prior to the task being carried out, an oil and refrigerant sample shall be taken in case analysis is required prior to re-use of reclaimed refrigerant. It is essential that electrical power is available before the task is commenced.
 - a) Become familiar with the equipment and its operation.
 - b) Isolate system electrically.

 **CAUTION**

- c) Before attempting the procedure ensure that:
 - Mechanical handling equipment is available, if required, for handling refrigerant cylinders;
 - All personal protective equipment is available and being used correctly;
 - The recovery process is supervised at all times by a competent person;
 - Recovery equipment and cylinders conform to the appropriate standards.
- d) Pump down refrigerant system, if possible.
- e) If a vacuum is not possible, make a manifold so that refrigerant can be removed from various parts of the system.
- f) Make sure that cylinder is situated on the scales before recovery takes place.
- g) Start the recovery machine and operate in accordance with manufacturer's instructions.
- h) Do not overfill cylinders. (No more than 80 % volume liquid charge).
- l) Do not exceed the maximum working pressure of the cylinder, even temporarily.
- j) When the cylinders have been filled correctly and the process completed, make sure that the cylinders and the equipment are removed from site promptly and all isolation valves on the equipment are closed off.
- k) Recovered refrigerant shall not be charged into another refrigeration system unless it has been cleaned and checked.

15. Labelling

- Equipment shall be labelled stating that it has been de-commissioned and emptied of refrigerant.
- The label shall be dated and signed.
- Ensure that there are labels on the equipment stating the equipment contains flammable refrigerant.

16. Recovery

- When removing refrigerant from a system, either for servicing or decommissioning, it is recommended good practice that all refrigerants are removed safely.
- When transferring refrigerant into cylinders, ensure that only appropriate refrigerant recovery cylinders are employed.
- Ensure that the correct number of cylinders for holding the total system charge is available.
- All cylinders to be used are designated for the recovered refrigerant and labelled for that refrigerant (i.e. special cylinders for the recovery of refrigerant).
- Cylinders shall be complete with pressure relief valve and associated shut-off valves in good working order.
- Empty recovery cylinders are evacuated and, if possible, cooled before recovery occurs.
- The recovery equipment shall be in good working order with a set of

 **CAUTION**

instructions concerning the equipment that is at hand and shall be suitable for the recovery of flammable refrigerants.

- In addition, a set of calibrated weighing scales shall be available and in good working order.
- Hoses shall be complete with leak-free disconnect couplings and in good condition.
- Before using the recovery machine, check that it is in satisfactory working order, has been properly maintained and that any associated electrical components are sealed to prevent ignition in the event of a refrigerant release.
- Consult manufacturer if in doubt.
- The recovered refrigerant shall be returned to the refrigerant supplier in the correct recovery cylinder, and the relevant Waste Transfer Note arranged.
- Do not mix refrigerants in recovery units and especially not in cylinders.
- If compressors or compressor oils are to be removed, ensure that they have been evacuated to an acceptable level to make certain that flammable refrigerant does not remain within the lubricant.
- The evacuation process shall be carried out prior to returning the compressor to the suppliers.
- Only electric heating to the compressor body shall be employed to accelerate this process.
- When oil is drained from a system, it shall be carried out safely.

DEHUMIDIFIER SAFETY

Your safety and safety of others are very important

We have provided many important safety messages in this manual and on your appliance. Always read and follow all safety messages.



This is the safety alert symbol.

This symbol alerts you to potential hazards that can kill or hurt you and others.

All safety messages will follow the safety alert symbol with the word "DANGER" or "WARNING"

These words mean:

⚠ DANGER

A hazard that if not avoided, will result in death or serious injury.

⚠ WARNING

A hazard that if not avoided, could result in death or serious injury.

All safety messages will tell you what the potential hazards are, tell you how to reduce the chance of injury and tell you what can happen if the instructions are not followed.

IMPORTANT SAFETY INSTRUCTIONS

⚠ DANGER To reduce the risk of explosion, fire, death, electric shock, scalding, or injury to persons when using this appliance, follow basic precautions, including the following:

INSTALLATION

- Plug into a grounded 3 prong outlet. Do not remove ground prong.
- Never attempt to operate this appliance if it is damaged, malfunctioning, partially disassembled, or has missing or broken parts, including a damaged cord or plug.
- Do not use an electrical adapter or multiple-outlet adaptors with this dehumidifier.
- Do not use an extension cord.
- Unplug dehumidifier before servicing.
- Do not drink water collected in the water bucket.
- The appliance is not intended for use by young children or impaired people without supervision, young children should be supervised to ensure that they do not play with the appliance.
- When installing or moving the appliance, be careful not to pinch, crush, or damage the power cord.
- Keep packing materials out of the reach of children. Packaging material can be dangerous for children. There is a risk of suffocation.
- Do not use the appliance in standing water or allow the product to be directly splashed by water during use.
- Store and install the appliance where it will not be exposed to temperatures below freezing or exposed to outdoor weather conditions.
- Call an authorized service technician to repair or immediately replace all power cords that have become damaged. Do not use a cord that shows cracks or abrasion damage along its length or at either end.

- Do not use the product if the outlet is damaged or loose.
- In the event of a gas leak (propane gas, LP gas, etc.) do not operate this or any other appliance. Open a window or door to ventilate the area immediately.
- Do not disassemble, repair or modify the product.
- Do not store or use flammable gases or materials near the dehumidifier.

OPERATION

- Read all instructions before using the appliance and save these instructions.
- Do not tamper with controls.
- Push the power plug all the way into the wall outlet so that it is not loose.
- Do not grasp the power cord or touch the appliance controls with wet hands.
- Do not modify or extend the power cord.
- If the product makes a strange noise or emits a smell or smoke, pull the power plug out and contact Hisense customer service.
- Avoid placing the dehumidifier or other heavy objects on top of the power cord.
- Do not use water to clean the dehumidifier.
- Keep the air inlet and outlet free from obstructions.
- Do not cover the power cord with a rug or carpeting. Placing heavy objects on top of the cord could damage it.
- Keep the product away from fire and high heat.
- Do not use the product in places where it could be splashed by water.
- Do not insert fingers, sticks etc. into the air inlet or outlet. The fan is running at high speeds and could cause personal injuries.
- Do not repair or replace any part of the appliance. All repairs and servicing must be performed by qualified service personnel unless specifically recommended in this owner's manual. Use only authorized factory parts.
- Connect to a properly rated, protected, and sized power circuit to avoid electrical overload.

SAVE THESE INSTRUCTIONS

▲ WARNING To reduce the risk of injury to persons, malfunction, or damage to the product or property when using this appliance, follow basic safety precautions, including the following:

INSTALLATION

- Use this appliance only for its intended purpose.
This product is not designed for preserving precision instruments, tableware or art works.
- Never unplug the appliance by pulling on the power cord. Always grip the plug firmly and pull straight out from the outlet.
- Do not use the product in places where chemicals are used.
Chemicals and solvents dissolved in the air could cause product deformation and leaking,
- Turn off the dehumidifier and pull out the power plug before cleaning.
Wait for the fan to stop moving.
- Do not operate the dehumidifier without a filter.
Using the product without a filter could result in a reduced product lifespan, electric shock or injury.

OPERATION

- Do not use the product for preserving animals/plants, precision instruments, art works etc.
- Do not place any objects on top of the dehumidifier.
- Turn off the dehumidifier and empty the water bucket before moving the dehumidifier.
- Pull out the power plug if you will not be using the product for an extended period.
- Do not use the product in a very small space such as a closet.
Poor ventilation could result in overheating.
- Do not use wax, thinner or a strong detergent when cleaning. Wipe the product using a soft cloth.
- Do not use the product in direct sunlight or rain.
- Do not touch the product with wet hands.
- Position the product on a firm, stable surface.
- Remove cable ties and extend power cord before use.
- Do not spray foreign substances or water on the product.

SAVE THESE INSTRUCTIONS

STORAGE AND DISPOSING OF THE UNIT

- Dispose of this appliance in accordance with Federal and Local regulations.
- Refrigerants must be evacuated before disposal.
- Please recycle or dispose of the packaging material of the product in an environment-friendly manner.
- To avoid damage to the compressor, never store or ship the appliance upside down or sideways.

INSTALLATION REQUIREMENTS

Electrical Requirements

⚠ WARNING



Electrical Shock Hazard

Always plug into a grounded three-prong outlet.

Do not remove ground prong.

Do not use an adapter.

Do not use an extension cord.

Failure to follow these instructions can result in death, fire, or electrical shock.

Specific electrical requirements are listed in the chart below. Follow the requirements for the type of plug on the power supply cord.

Power Supply Requirements



- 220-240V ~ / 50Hz
- 15A time-delay fuse or circuit breaker

Recommended Grounding Method

This dehumidifier must be grounded. This dehumidifier is equipped with a power supply cord with a three-prong grounding plug. The cord must be plugged into a mating, grounded three-prong outlet, grounded in accordance with all local codes and ordinances. If a mating outlet is not available, it is the customer's responsibility to have a properly grounded three-prong outlet installed by a qualified electrician.

It is the customer's responsibility:

- To contact a qualified electrical installer.
- To assure that the electrical installation is adequate and conforms to the Nation Electrical Code, ANSI/NFPA 70-last edition, and all local codes and ordinances.

Location Requirements

⚠ WARNING To reduce the risk of injury to persons, malfunction, or damage to the product or property when using this appliance, follow basic safety precautions, including the following:

NOTE:

- Your model may differ from the one shown.
- This product cannot be used or stored in a confined space (floor area must larger than 5m²).
- Do not locate outdoors. This dehumidifier is intended for indoor residential use only (It shall be installed, operated and stored in a unconfined space with a floor area larger than 5m²). This dehumidifier is not recommended for commercial use.
- Allow at least 30.5 cm to 45.7 cm of space on the rear and sides of the dehumidifier for models with back louver and above the dehumidifier for models with top louvers.
- You will need a surface strong enough to support the dehumidifier, Do not place on a carpet, Ensure that the dehumidifier is securely placed before running, prevent dumping.
- You will need a surface level enough to keep the water from spilling when the bucket is full of water.
- Do not block the louvers of the unit .
- Never operate this dehumidifier in an area that is likely to accumulate standing water. If this condition develops, for your safety disconnect the power supply before stepping into the water.
- Turn off the dehumidifier, unplug the power supply cord and empty the bucket before moving the unit, prevent the water leakage or electric shock.

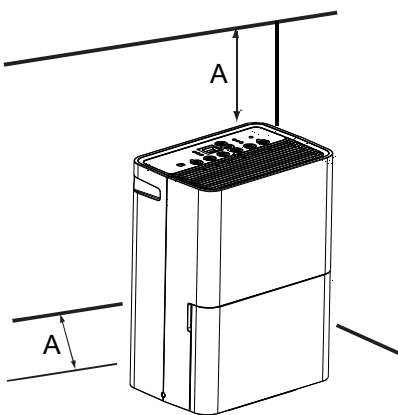

A. 30.5cm to 45.7cm

DEHUMIDIFIER USE

Setting the Controls

Control Panel

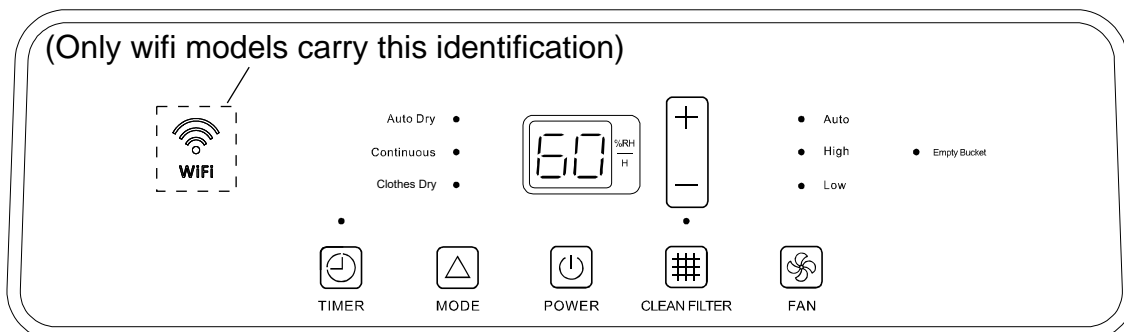

NOTE:

- Set point is Relative Humidity: lower is more dry, higher is less dry.
- The control panel of your model may differ from the one shown above.

Starting/Stopping the Dehumidifier

⚠ WARNING The dehumidifier should be upright for at least 2 hours before use.

⚠ WARNING Do not pull out the water bucket during normal use, otherwise there may be electric shock risk. If you want to move the dehumidifier, be sure that pull out the power plug at first.

NOTE:

- Before turning on the dehumidifier, be sure that the bucket is empty and fits all the way into the dehumidifier.
- Each time you unplug the dehumidifier or power is interrupted, the controls will return to the previous settings when power is restored.
- Humidity displayed is between 30% Relative Humidity and 90% Relative Humidity.
- Humidity can be set between 30% Relative Humidity and 80% Relative Humidity.
- It's important to set the desired humidity level to an achievable setting. To ensure energy-efficient operation, only use the dehumidifier in a closed space, with no open windows or other sources of moist air (to avoid continuous running).
- Operating temperature is between 5°C to 32°C. Operating humidity is between 30% RH to 80% RH. At temperatures of 5°C or less, water freezes inside the product. At temperatures over 32°C, the internal temperature of the product trips a protective device which deactivates the product to avoid product damage.
- The compressor has a 3-minute delay before restarting. If the product is stopped and immediately restarted, to protect the compressor there is a 3-minute delay until the compressor restarts.

- When the dehumidifier is operating, the indoor temperature will rise. The dehumidifier does not have a cooling /heating function. Heat is generated during operation, so the room temperature may be increased by about 5°C depending on the usage conditions (indoor temperature, size of the room).

⚠ WARNING



Electric Shock Hazard

Always plug into a grounded three-prong outlet.

Do not remove ground prong.

Do not use an adapter.

Do not use an extension cord.

Failure to follow these instructions can result in death, fire or electric shock.

1. Plug into a grounded three-prong outlet.
2. Press POWER to turn on the dehumidifier.
3. Press FAN to choose the fan speed.
4. Press MODE to choose the mode(Auto Dry/Continuous/Clothes Dry/Manual Set).
5. Press the plus or minus button to set the level of humidity in manual set mode.
6. Press POWER to turn off the dehumidifier.



NOTE:

In the case of a power outage or interruption, the dehumidifier will automatically restart, in the settings last used, after the power is restored.

Fan Speed

1. Press FAN to select fan speed.
2. Choose Low High or Auto .



- Low-Reach the desired humidity setting with lower sound level.
- High-Will more quickly reach the desired humidity setting.
- Auto-Achieves set humidity at normal speed.

NOTE:

Once the relative humidity of the room hit the desired setting, the compressor will stop and the fan will be off periodically.

The fan may periodically turn on, to read the humidity level, without the compressor running.

Desired Humidity-Mode

1. Press MODE to select the desired humidity setting.

- Auto Dry Mode : Auto Dry light is on.
- Continous Dry Mode:Continous Dry light is on.
- Clothes Dry Mode:Clothes Dry light is on.
- Manual Set Mode: Auto Dry light and Continous Dry light and Clothes Dry light are off.



2. Choose Auto Dry, Continuous ,Clothes Dry or Manual Set.

- Auto Dry: The dehumidifier will operate in dry mode only. The fan speed is set automatically. The desired humidity is set to 50% automatically.
- Continuous: The dehumidifier will operated continuously. The fan speed can be adjusted. The desired humidity can not be adjusted.
- Clothes Dry:The dehumidifier operates in a strong dehumidification mode and automatically dry clothes according to the actual room humidity. At the end of the drying operation, the drying mode will automatically exit and the Clothes Dry indicator will start flashing. When you press the mode key again,you will re-enter the drying mode, and the mode indicator will change from flashing to turn on.The desired humidity can not be adjusted.
- Manual Set: The dehumidifier will operate at the selected fan speed to the set humidity level. If the humidity level of the room is higher than the desired humidity setting, the compressor will turn on. If the humidity level of the room is lower than the desired humidity setting, the compressor will turn off, as well as the fan.

NOTE:

The de-icing function will turn off the compressor if a low temperature condition occurs. When the de-icer senses the correct operating temperature, the compressor will cycle back on. Some freezing is normal when dehumidifiers are used at low temperatures.

Empty Bucket Light

If this light is on, the fan and the compressor will

stop running. This light indicates that you need to check:

- If the bucket is full, empty and re-install bucket.
- If the bucket is not in position, remove the bucket and re-install it. Make sure the bucket fits all the way into the dehumidifier and the bucket light is off, or dehumidifier will not run.

Power

Press POWER to turn on or turn off the dehumitifier.

**Humidity Level**

1. Press the Plus or Minus button to set the desired humidity level. Desired humidity in the digital display will flash for 5 seconds after operation.

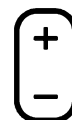

2. Actual room humidity will be displayed after 5 seconds of flashing the desired humidity.

NOTE:

Humidity can only be adjusted manually in Manual Set mode. In Continuous and Auto Dry mode, humidity level is set automatically.

Digital Display

Display shows relative humidity or time (depending on setting).

1. When the dehumidifier operates in Manual Set mode, the display shows the relative humidity of the room.
2. When the timer is selected, the display shows the time when the dehumidifier will turn on or turn off operates, depending on the setting.

**NOTE:**

The humidity displayed is only for reference. For accurate humidity, please check a hygrometer.

Timer

To set Timer for a 30-minute to 24-hour delay before the dehumidifier is turned off (the dehumidifier must be On):

1. Press TIMER. Timer indicator light will come on, and the display will flash. The display will show remaining time before the dehumidifier will turn off.



2. Press the Plus or Minus button to change the delay time, from 30 minutes to 24 hours.

To set Timer to turn on the dehumidifier, with previous setting:

1. Turn off the dehumidifier.
2. Press TIMER. Timer indicator light will flash. The display will show remaining time before the dehumidifier will turn on.
3. Press the Plus or Minus button to change the delay time, from 30 minutes to 24 hours.

To clear the Timer delay program:

NOTE: Dehumidifier can be either on or off.

1. Press TIMER once after it has been programmed. Display will show remaining time.
2. While the display is showing the remaining time, press TIMER again. Timer indicator light will turn off.

To see the remaining time.

Press TIMER once after it has been programmed. Display will show remaining time.

NOTE:

Empty the drain water bucket before setting the timer function. If the water bucket becomes full during the Timer function, the Empty Bucket light goes on and dehumidification stops.

Clean Filter

1. When the Clean Filter indicator light is on, remove, clean and replace the air filter. See "Cleaning the Air Filter".
2. Press the Clean Filter button to reset the filter monitor.



NOTE:

When the light is on, it will remain on for 180 hours or until you press Clean Filter button.

Draining the Dehumidifier

⚠ WARNING

Sickness Hazard

Do not drink water collected in water bucket.
Doing so can result in sickness.

Option 1 Bucket Draining

If a floor drain is not available, or you do not plan to run your dehumidifier continuously, you may want to simply empty the bucket.

1. Grasp the bucket sides to slide out bucket.

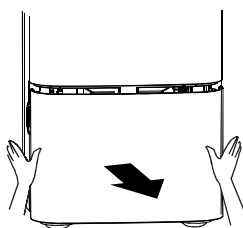

2. Lift the bucket up by the handle.

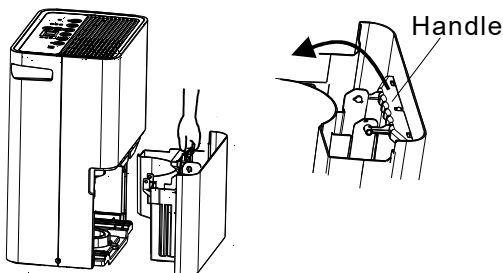

3. Pour water into a sink or tub.

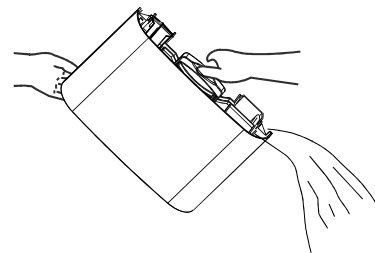

4. Fold down the handle and reinstall the bucket.

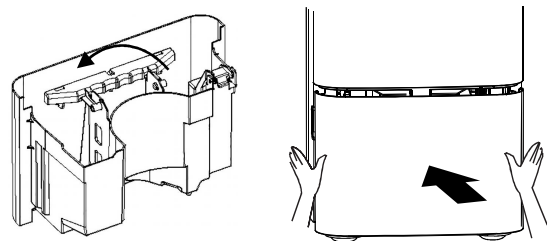

IMPORTANT:

If the Empty Bucket light comes on, the dehumidifier will not operate. The bucket may need to be emptied or re-installed.

NOTE:

- If the water bucket is removed immediately after turning off the dehumidifier, the water remaining in the heat exchanger may drip inside the water bucket storage area. Remove the water with a soft cloth.
- While cleaning, do not touch the water level float.
- Clean the water bucket once a week during use.
- If the ambient temperature is low, there is less moisture in the air for the product to remove.
- Unplug the product before removing the water bucket. If the bucket is removed while the product is operating, the compressor will stop.

Option 2 Gravity Draining

If you plan to run your dehumidifier continuously, you can choose direct draining by attaching a garden hose to the unit.

1. Turn off the dehumidifier and unplug the power supply cord.
2. Uncover the connector cover on the side of the unit.

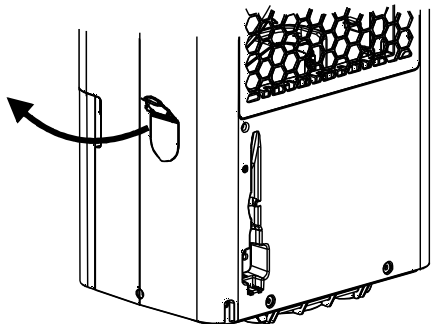

3. Remove bucket.
4. Attach a garden hose to the drain hose connector on the inside of the dehumidifier. Securely attach the hose to be sure there is no water leak.

NOTE:

- The garden hose sold separately.
- And the drain hose inner diameter should be greater than 12.7mm.
- The connector is designed for North American garden hoses only.

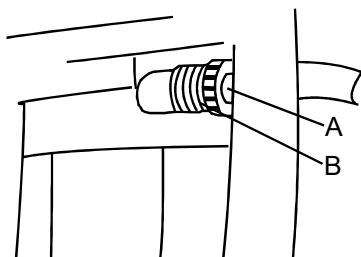

A. Garden hose
B. Drain hose connector

IMPORTANT:

In North America the garden hose connectors are 3/4 diameter straight (non-tapered) thread with a pitch of 4.52 threads per cm (male part has an outer diameter of 26.99mm).

⚠ WARNING Take care not to injure hands while connecting the hose.

5. Place the other end of garden hose into a floor drain. Check to see that the hose lies flat and is in the drain. Make sure all the parts of the hose is on a lower level than the hose connector on the dehumidifier. Also, the outlet of the hose should be at least 14cm lower than the hose connector. The hose should not be kinked or pinched.

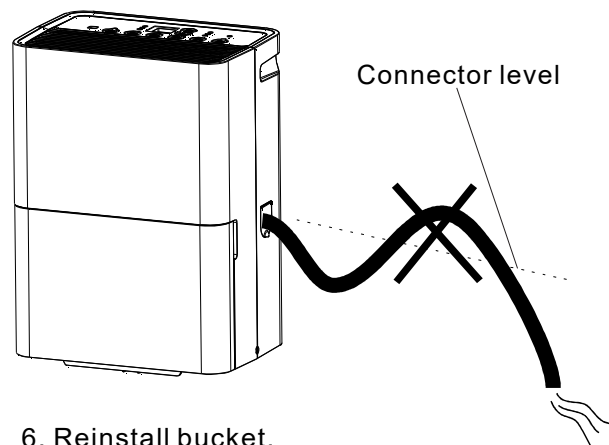
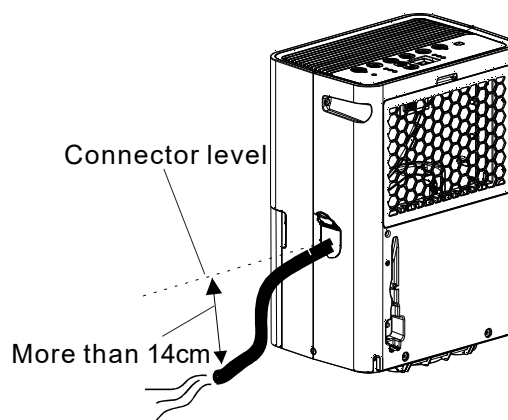

6. Reinstall bucket.

NOTE:

- To use the bucket without the garden hose, simply remove the garden hose, then reinstall bucket.
- The bucket must be installed and properly aligned for the dehumidifier to operate with or without a garden hose connected.

Normal Sounds

When your dehumidifier is operating normally, you may hear sounds such as:

- Compressor sounds, which may be loud.
- Air movement from the fan.
- Clicking sounds when the dehumidifier or compressor turns on and off, and when the Automatic shut-off Switch is working.

DEHUMIDIFIER CARE

Your new dehumidifier is designed to give you many years of dependable service. This section explains how to clean and care for your dehumidifier.

To avoid damage to the compressor, never store or ship the appliance upside down or sideways.

Cleaning the Air Filter

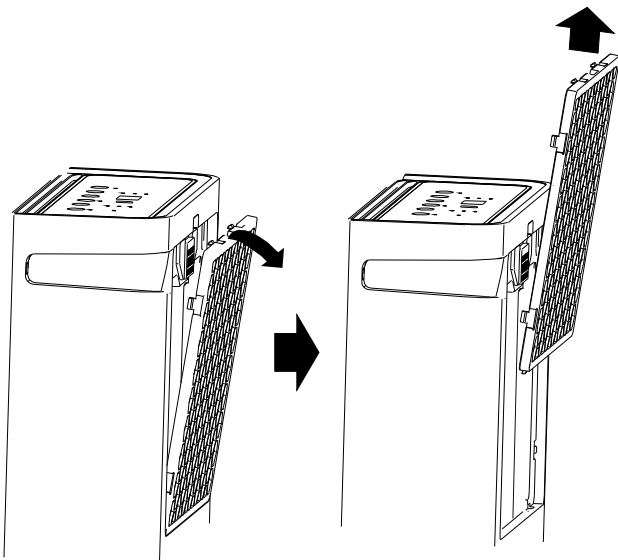

The air filter is removable for easy cleaning. A clean filter helps remove dust, lint, and other particles from the air and is important for best operating efficiency. Check the filter every two weeks to see whether it needs cleaning.

1. Turn off the dehumidifier.
2. Remove the air filter.
3. Use a vacuum cleaner to clean the air filter if the air filter is dirty, wash it in warm water with a mild detergent.
4. Reinstall the air filter.
5. Turn on the dehumidifier.

NOTE:

Do not wash air filter in the dishwasher or use any chemical cleaner. Air dry filter completely before reinstalling to ensure maximum operating efficiency.

Cleaning the Dehumidifier

Exterior

1. Turn off the dehumidifier and unplug the power supply cord.
2. Dust the surface of the unit with a soft cloth or the dusting attachment of your vacuum cleaner.

Water Bucket

Every few weeks, rinse the inside of the water bucket with a mild detergent to avoid growth of mold, mildew and bacteria.

Water level float

The dehumidifier's water bucket has a water level float. Do not damage or remove the bucket's water level float. If the float is not properly in place, the Empty Bucket light will turn on, preventing operation, and could result in leaking.

NOTE:

Be sure the float is snapped correctly in place.

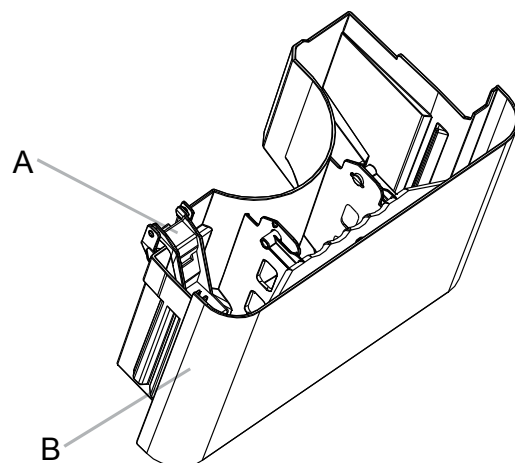

- A. Water level float
B. Bucket

TROUBLE SHOOTING

Before calling for service, try the suggestions below.

Dehumidifier will not run

- Is the dehumidifier turned on?
Turn on the dehumidifier.

⚠ WARNING



Electrical Shock Hazard

Plug into a grounded three-prong outlet.
Do not remove ground prong.
Do not use an adapter.
Do not use an extension cord.
Failure to follow these instructions can result in death,
fire or electric shock.

- Is the power cord plugged into a grounded three-prong outlet?
Plug into a grounded three-prong outlet. See “Electrical Requirements” on page 12.
- Has a household fuse blown or has a circuit breaker tripped?
Replace the fuse or reset the circuit breaker. If the problem continues, call an electrician. See “Electrical Requirements” on page 12.

- Is the bucket installed properly?
Reinstall the bucket so that it fits all the way into the dehumidifier.
- Does the bucket need to be emptied?
Empty the bucket.
- Is the water level float in place?
Remove the bucket. Make sure the float is snapped in place. Reinstall the bucket.
- Did the dehumidifier suddenly stop operating, and won't turn on?
Confirm the power is connected, and the bucket is in place. If the unit still doesn't operate, call Hisense for Warranty service.

Dehumidifier runs but does not dehumidify

- All models have an automatic de-icing function that will shut off the compressor and allow the fan to run.
When the de-icing function senses the correct operating temperature, the compressor will cycle back on.
- The filter is dirty or obstructed debris.
Clean the filter.

Air coming from the dehumidifier is warm

- Dehumidifier will put out warm air under normal operating conditions.

Dehumidifier displays error codes

- If the dehumidifier displays an error code, please contact Hisense customer service.

CIRCUIT DIAGRAM

